



ELECTROSTATIC SENSITIVE DEVICE
OBSERVE HANDLING PRECAUTIONS

MITSUBISHI RF POWER MOS FET

RD30HVF1

Silicon MOSFET Power Transistor, 175MHz, 30W

DESCRIPTION

RD30HVF1 is a MOS FET type transistor specifically designed for VHF RF power amplifiers applications.

FEATURES

- High power gain:
Pout>30W, Gp>14.7dB @Vdd=12.5V, f=175MHz
- High Efficiency: 60%typ.

APPLICATION

For output stage of high power amplifiers in VHF band Mobile radio sets.

OUTLINE DRAWING

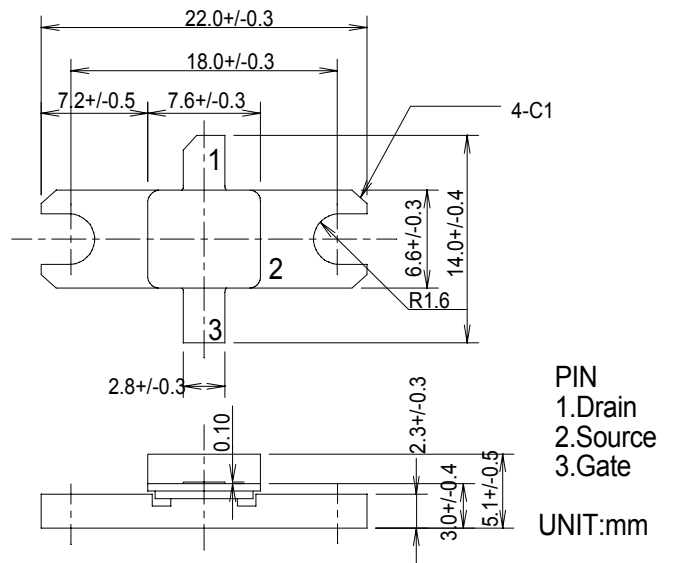

ABSOLUTE MAXIMUM RATINGS

(Tc=25°C UNLESS OTHERWISE NOTED)

SYMBOL	PARAMETER	CONDITIONS	RATINGS	UNIT
VDSS	Drain to source voltage		30	V
VGSS	Gate to source voltage		+/-20	V
Pch	Channel dissipation	Tc=25°C	75	W
Pin	Input power	Zg=Zl=50Ω	2.5	W
Tj	Junction temperature		175	°C
Tstg	Storage temperature		-40 to +175	°C
Rth-c	Thermal resistance	Junction to case	2.0	°C/W

Note 1: Above parameters are guaranteed independently.

ELECTRICAL CHARACTERISTICS (Tc=25°C, UNLESS OTHERWISE NOTED)

SYMBOL	PARAMETER	CONDITIONS	LIMITS			UNIT
			MIN	TYP	MAX.	
IDSS	Zero gate voltage drain current	VDS=17V, VGS=0V	-	-	200	μA
IGSS	Gate to source leak current	VGS=10V, VDS=0V	-	-	1	μA
VTH	Gate threshold voltage	VDS=12V, IDS=1mA	1.3	1.8	2.3	V
Pout	Output power	f=175MHz, VDD=12.5V	30	35	-	W
ηD	Drain efficiency	Pin=1.0W, Idq=0.5A	55	60	-	%
	Load VSWR tolerance	VDD=15.2V, Po=30W(PinControl) Idq=0.5A, Zg=50Ω Load VSWR=20:1(All Phase)	No destroy			-

Note : Above parameters , ratings , limits and conditions are subject to change.



ELECTROSTATIC SENSITIVE DEVICE
OBSERVE HANDLING PRECAUTIONS

MITSUBISHI RF POWER MOS FET

RD30HVF1

Silicon MOSFET Power Transistor, 175MHz, 30W

TYPICAL CHARACTERISTICS

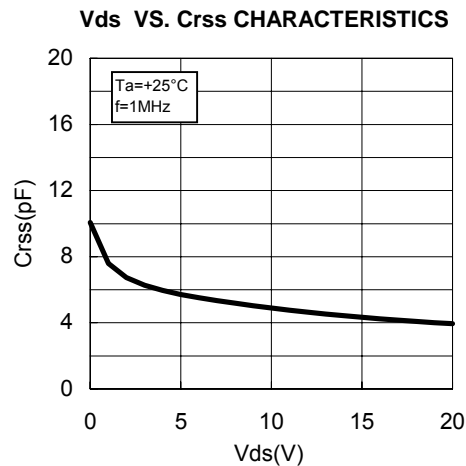
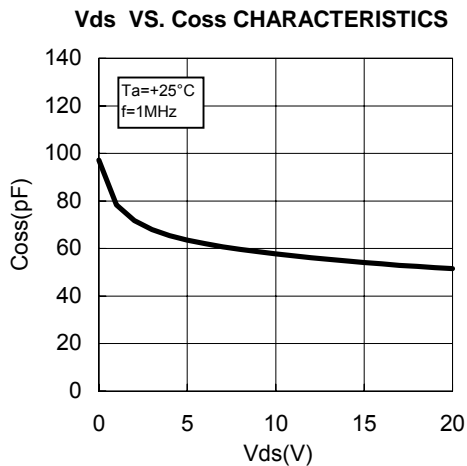
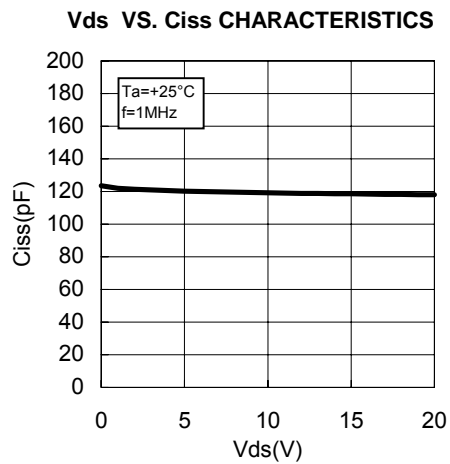
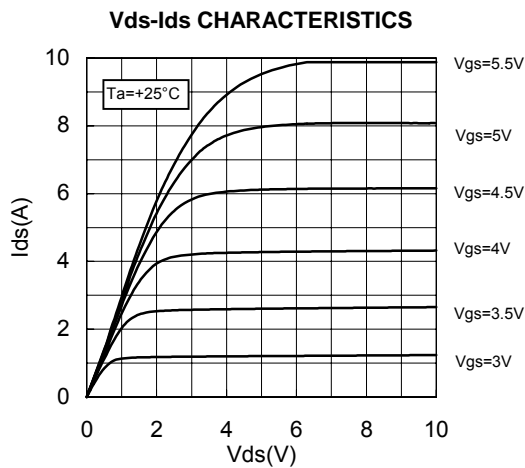
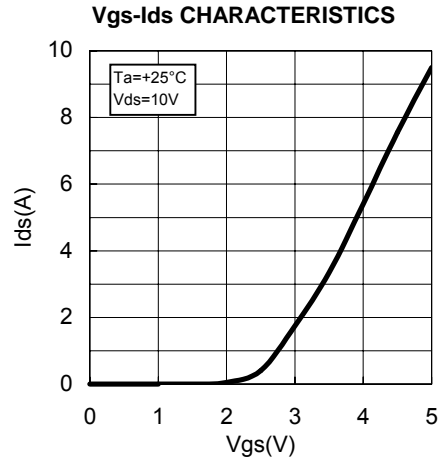
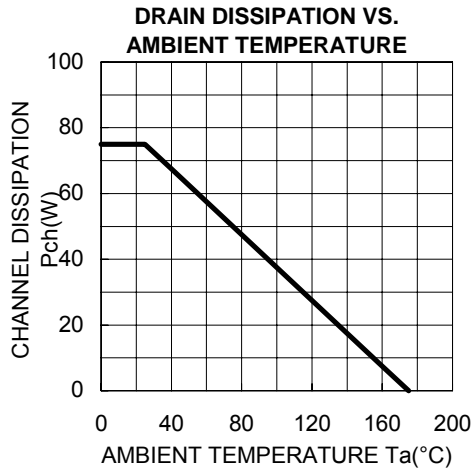



ELECTROSTATIC SENSITIVE DEVICE
OBSERVE HANDLING PRECAUTIONS

MITSUBISHI RF POWER MOS FET

RD30HVF1

Silicon MOSFET Power Transistor, 175MHz, 30W

TYPICAL CHARACTERISTICS

Pin-Po CHARACTERISTICS

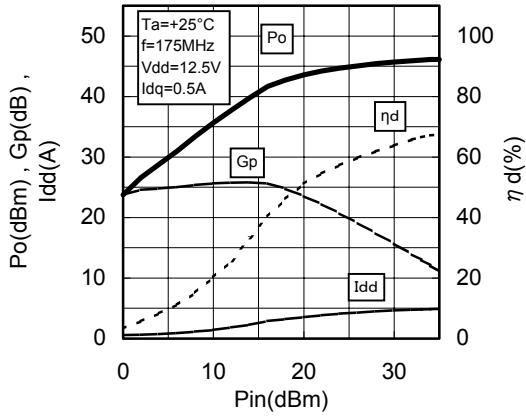

Pin-Po CHARACTERISTICS

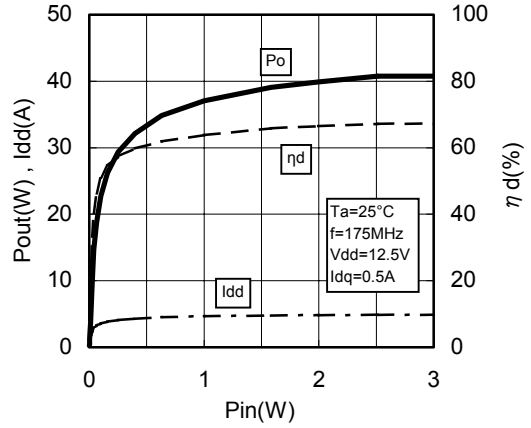

Vdd-Po CHARACTERISTICS

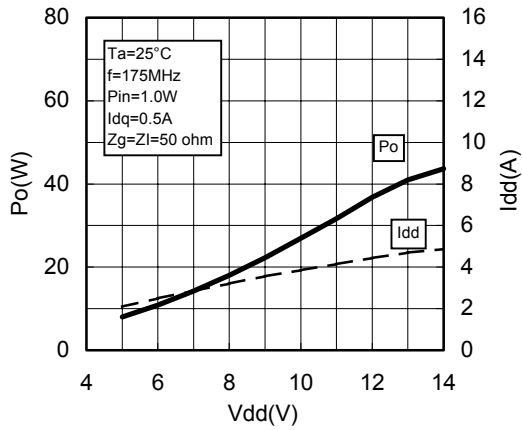

Vgs-Ids CHARACTERISTICS 2

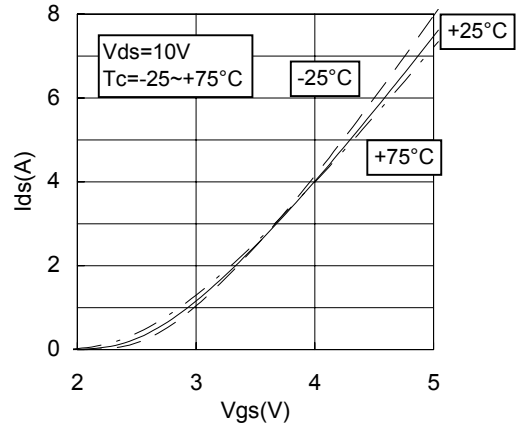



ELECTROSTATIC SENSITIVE DEVICE
OBSERVE HANDLING PRECAUTIONS

MITSUBISHI RF POWER MOS FET

RD30HVF1

Silicon MOSFET Power Transistor, 175MHz, 30W

EQUIVALENT CIRCUIT(f=175MHz)

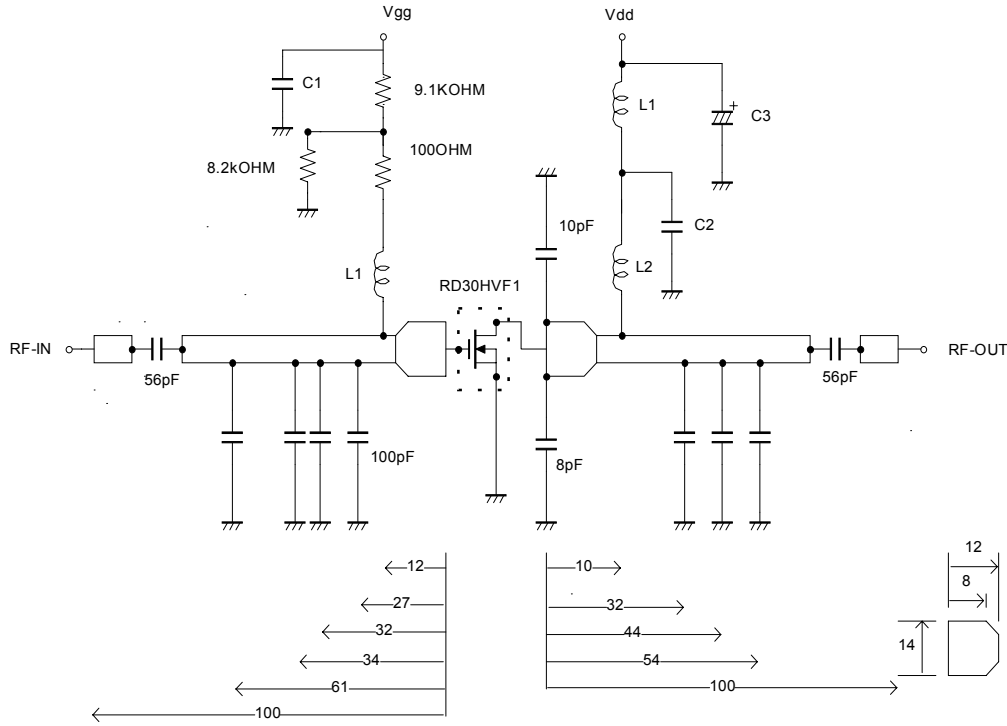

C1: 2200pF, 10uF in parallel

C2: 2200pF * 2 in parallel

C3: 2200pF, 330uF in parallel

L1: 4 Turns, l.D6mm, D1.6mm P=1 silver plated copper wire

L2: 5 Turns, l.D6mm, D1.6mm P=1 silver plated copper wire

Note: Board material-Teflon substrate

Micro strip line width=4.2mm/50OHM, er:2.7, t=1.6mm

Dimensions:mm



ELECTROSTATIC SENSITIVE DEVICE
OBSERVE HANDLING PRECAUTIONS

MITSUBISHI RF POWER MOS FET

RD30HVF1

Silicon MOSFET Power Transistor, 175MHz, 30W

INPUT/OUTPUT IMPEDANCE VS. FREQUENCY CHARACTERISTICS

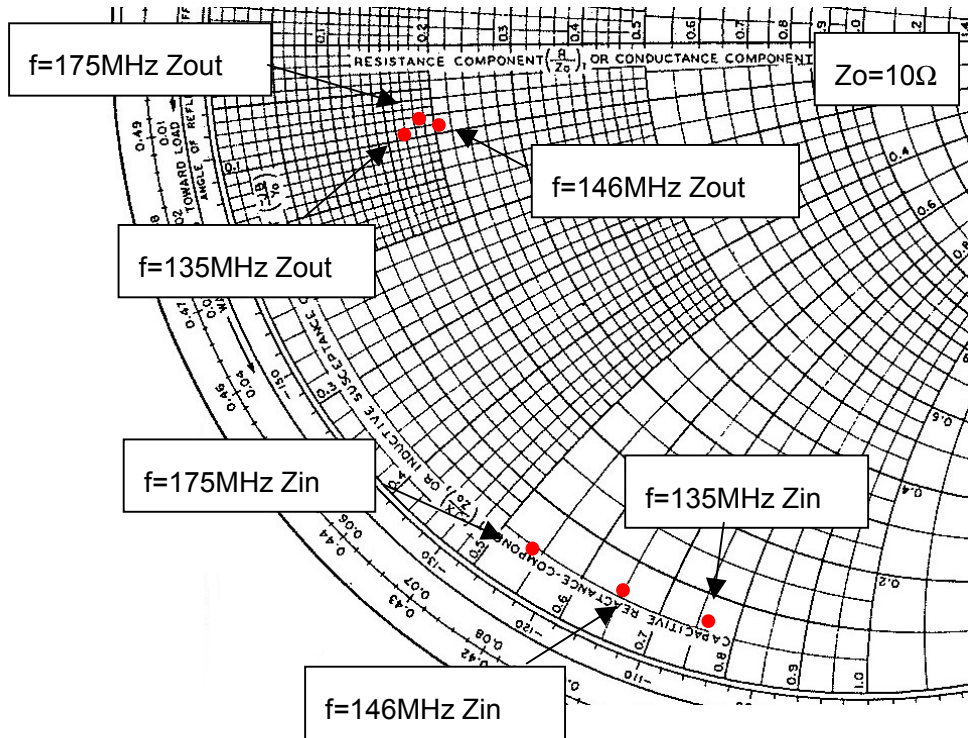

Z_{in} , Z_{out}

f (MHz)	Z_{in} (ohm)	Z_{out} (ohm)	Conditions
135	0.71-j7.67	1.72-j0.86	$P_o=40W$, $V_{dd}=12.5V$, $P_{in}=1.0W$
146	0.94-j6.46	2.12-j0.78	$P_o=38W$, $V_{dd}=12.5V$, $P_{in}=1.0W$
175	0.53-j5.34	1.87-j0.70	$P_o=35W$, $V_{dd}=12.5V$, $P_{in}=1.0W$



ELECTROSTATIC SENSITIVE DEVICE
OBSERVE HANDLING PRECAUTIONS

MITSUBISHI RF POWER MOS FET

RD30HVF1

Silicon MOSFET Power Transistor, 175MHz, 30W

RD30HVF1 S-PARAMETER DATA (@V_{dd}=12.5V, I_d=500mA)

Freq. [MHz]	S11		S21		S12		S22	
	(mag)	(ang)	(mag)	(ang)	(mag)	(ang)	(mag)	(ang)
100	0.867	-172.4	0.015	-11.6	8.747	72.7	0.687	-166.3
150	0.879	-176.3	0.014	-18.8	5.523	61.2	0.723	-168.8
175	0.885	-177.5	0.013	-22.2	4.571	56.4	0.740	-169.6
200	0.888	-179.1	0.012	-24.2	3.852	52.4	0.760	-170.5
250	0.905	178.5	0.010	-26.2	2.877	44.1	0.806	-172.5
300	0.915	176.2	0.009	-27.0	2.202	37.1	0.825	-174.8
350	0.926	174.1	0.007	-24.4	1.754	31.4	0.853	-177.1
400	0.933	171.8	0.006	-18.5	1.422	25.8	0.879	-179.4
450	0.936	169.5	0.005	-8.2	1.167	20.9	0.887	178.4
500	0.945	167.6	0.004	8.0	0.985	17.2	0.902	176.1
550	0.950	165.6	0.005	21.6	0.842	13.3	0.914	174.1
600	0.951	163.6	0.005	35.6	0.725	9.8	0.918	172.2
650	0.954	161.7	0.005	45.7	0.635	7.2	0.928	170.2
700	0.957	159.9	0.007	53.5	0.559	3.7	0.933	168.4
750	0.962	158.2	0.007	58.4	0.495	1.3	0.936	166.6
800	0.963	156.5	0.008	61.6	0.449	-0.5	0.943	164.8
850	0.963	154.8	0.009	60.7	0.407	-3.8	0.947	163.3
900	0.963	153.2	0.011	61.5	0.366	-5.2	0.947	161.7
950	0.962	151.6	0.011	63.1	0.337	-6.6	0.953	159.9
1000	0.964	150.1	0.013	65.6	0.315	-9.9	0.955	158.7
1100	0.966	146.9	0.015	62.3	0.275	-12.1	0.958	155.5



ELECTROSTATIC SENSITIVE DEVICE
OBSERVE HANDLING PRECAUTIONS

MITSUBISHI RF POWER MOS FET

RD30HVF1

Silicon MOSFET Power Transistor, 175MHz, 30W

—————Keep safety first in your circuit designs! —————

Mitsubishi Electric Corporation puts the maximum effort into making semiconductor products better and more reliable, but there is always the possibility that trouble may occur with them. Trouble with semiconductors may lead to personal injury, fire or property damage. Remember to give due consideration to safety when making your circuit designs, with appropriate measures such as (i) placement of substitutive, auxiliary circuits, (ii) use of non-flammable material or (iii) prevention against any malfunction or mishap.